



**Congressional
Research Service**

Informing the legislative debate since 1914

Carbon Capture and Sequestration (CCS) in the United States

Updated October 5, 2022

Congressional Research Service

<https://crsreports.congress.gov>

R44902



Carbon Capture and Sequestration (CCS) in the United States

R44902

October 5, 2022

Angela C. Jones

Analyst in Environmental Policy

Ashley J. Lawson

Analyst in Energy Policy

Carbon capture and storage (or sequestration)—known as CCS—is a process intended to capture man-made carbon dioxide (CO₂) at its source and store it permanently underground. As one potential option for greenhouse gas mitigation, CCS could reduce the amount of CO₂—an important greenhouse gas—emitted to the atmosphere from power plants and other large industrial facilities. The concept of carbon utilization has also gained interest within Congress and in the private sector as a means for capturing CO₂ and converting it into potentially commercially viable products, such as chemicals, fuels, cements, and plastics, thereby reducing emissions to the atmosphere and helping offset the cost of CO₂ capture. CCS is sometimes referred to as CCUS—carbon capture, *utilization*, and storage. Direct air capture (DAC) is a related and emerging technology designed to remove atmospheric CO₂ directly.

The U.S. Department of Energy (DOE) has funded research and development (R&D) in aspects of CCS since at least 1997 within its Fossil Energy and Carbon Management Research, Development, Demonstration, and Deployment program (FECM) portfolio. Since FY2010, Congress has provided a total of \$9.2 billion (in constant 2022 dollars) in annual appropriations for FECM, of which \$2.7 billion (in constant 2022 dollars) was directed to CCS-related budget line items. The Infrastructure Investment and Jobs Act (IIJA; P.L. 117-58) provided \$8.5 billion (nominal dollars) in supplemental funding for CCS for FY2022-FY2026, including funding for the construction of new carbon capture facilities, plus another \$3.6 billion (nominal dollars) for DAC.

U.S. facilities capturing and injecting CO₂, and projects under development, operate in five industry sectors: chemical production, hydrogen production, fertilizer production, natural gas processing, and power generation. Most projects use the injected CO₂ to increase oil production from aging oil fields, known as enhanced oil recovery (EOR), while some facilities capture and inject CO₂ with the aim to sequester the CO₂ in underground geologic formations. The Petra Nova project in Texas, starting operation in 2017, was the first and only U.S. fossil-fueled power plant generating electricity and capturing CO₂ in large quantities (over 1 million metric tons per year) until CCS operations were suspended in 2020.

The U.S. Environmental Protection Agency (EPA), under authorities to protect underground sources of drinking water, regulates CO₂ injection through its Underground Injection Control (UIC) program and associated regulations. While the agency establishes minimum standards and criteria for UIC programs, most states have the responsibility for regulating and permitting wells injecting CO₂ for EOR (classified as Class II recovery wells).

Congress has incentivized development of CCS projects through creation of the Internal Revenue Code Section 45Q tax credit for carbon sequestration, its use as a tertiary injectant for EOR, or other designated purposes. Recent Internal Revenue Service guidance and regulations on this tax credit are intended to provide increased certainty for industry by establishing processes and standards for “secure geologic storage of CO₂,” among other requirements.

Several provisions in the Consolidated Appropriations Act, 2021 (P.L. 116-260) aim to further support CCS project development in the United States. The act revised and expanded DOE’s ongoing CCS research, development, and demonstration activities, established expedited federal permitting eligibility for CO₂ pipelines (where applicable), and extended the start-of-construction deadline for facilities eligible for the Section 45Q tax credit, among other provisions. IIJA included additional supportive provisions. P.L. 117-169, commonly known as the Inflation Reduction Act of 2022, contained several provisions related to the 45Q tax credit that increase the amount of the tax credit for certain facilities and extend the deadline for start of construction, among other provisions.

There is broad agreement that costs for constructing and operating CCS would need to decrease before the technologies could be widely deployed. In the view of many proponents, greater CCS deployment is fundamental to reduce CO₂ emissions (or reduce the concentration of CO₂ in the atmosphere, in the case of DAC) and to help mitigate human-induced climate change. In contrast, some stakeholders do not support CCS as a mitigation option, citing concerns with continued fossil fuel combustion and the uncertainties of long-term underground CO₂ storage.

Contents

CCS Primer.....	2
CO ₂ Capture.....	4
Postcombustion Capture	4
Precombustion Capture (Gasification).....	5
Oxy-Fuel Combustion Capture	6
Allam Cycle	7
CO ₂ Transport.....	8
CO ₂ Injection and Sequestration	9
Oil and Gas Reservoirs	10
Deep Saline Reservoirs	10
Unmineable Coal Seams	11
Carbon Utilization.....	11
Commercial CCS Facilities	14
Petra Nova: The First Large U.S. Power Plant with CCS	17
Boundary Dam: World’s First Addition of CCS to a Large Power Plant.....	18
The DOE CCS Program	18
EPA Regulation of Underground Injection in CCS	23
Discussion	26
Council on Environmental Quality 2021 CCS Report to Congress and 2022 CCS Guidance	26
Other CCS Policy Issues	27

Figures

Figure 1. Options for an Integrated CCS Process: Capture, Injection, and Utilization	3
Figure 2. Diagram of Postcombustion CO ₂ Capture in a Coal-Fired Power Plant Using an Amine Scrubber System.....	5
Figure 3. Diagram of Precombustion CO ₂ Capture from an IGCC Power Plant.....	6
Figure 4. Diagram of Oxy-Combustion CO ₂ Capture from a Coal-Fired Power Plant	7
Figure 5. Schematic Illustration of Current and Potential Uses of CO ₂	12
Figure 6. Location of U.S. Carbon Capture and Injection Projects.....	14
Figure 7. Operational, Planned, and Suspended Facilities in the United States Injecting CO ₂ for Geologic Sequestration and EOR	16

Tables

Table 1. Estimates of the U.S. Storage Capacity for CO ₂	9
Table 2. Annual Appropriations for DOE Fossil Energy and Carbon Management (FECM) Research, Development, Demonstration, and Deployment Program Areas	19
Table 3. Infrastructure Investment and Jobs Act Supplemental Appropriations for Carbon Capture and Storage Programs	22

Contacts

Author Information..... 28

Carbon capture and storage (or sequestration)—known as CCS—is a process intended to capture man-made carbon dioxide (CO₂) at its source and store it to avoid its release to the atmosphere. CCS is sometimes referred to as CCUS—carbon capture, *utilization*, and storage. CCS could reduce the amount of CO₂ emitted to the atmosphere from power plants and other large industrial facilities. An integrated CCS system would include three main steps: (1) capturing and separating CO₂ from other gases; (2) transporting the captured and compressed CO₂ to the storage or sequestration site; and (3) injecting the CO₂ in underground geological reservoirs (the process is explained more fully below in “CCS Primer”). The *utilization* part of CCUS has been of increased interest to researchers and policymakers. *Utilization* refers to the beneficial use of CO₂—in lieu of storing it—as a means of mitigating CO₂ emissions and converting it to chemicals, cements, plastics, and other products.¹ This report uses the term *CCS* except in cases where utilization is specifically discussed.

The U.S. Department of Energy (DOE) has long supported research and development (R&D) on CCS, currently within its Fossil Energy and Carbon Management Research, Development, Demonstration, and Deployment program (FECM).² From FY2010 to FY2022, Congress provided a total of \$9.2 billion (2022 dollars)³ in annual appropriations for FECM, of which \$2.7 billion (2022 dollars) was directed to CCS-related budget line items. Additionally, Congress provided a supplemental appropriation of \$3.4 billion (\$4.4 billion in 2022 dollars) for CCS in the American Recovery and Reinvestment Act of 2009 (ARRA; P.L. 111-5). It provided another supplemental appropriation of \$8.5 billion (nominal dollars) for CCS in the Infrastructure Investment and Jobs Act (IIJA; P.L. 117-58) for FY2022 to FY2026.⁴ Congress has expressed support for continuing federal investment in CCS research and development—including financial support for demonstration projects—through the appropriations process in recent years and in DOE research reauthorizations provided in the Energy Act of 2020 (Division Z of the Consolidated Appropriations Act, 2021; P.L. 116-260). The IIJA provided funding for several programs authorized by the Energy Act of 2020 and established other programs aimed to promote CCS in the United States, as discussed later in this report.

Congress has also enacted tax credits for facilities that capture and sequester CO₂—one strategy for incentivizing CCS project deployment. In 2022, Congress enacted as part of P.L. 117-260, commonly known as the Inflation Reduction Act of 2022 (IRA), provisions that increased the tax credit for sequestering or utilizing CO₂, referred to as the “Section 45Q” tax credit.⁵ The IRA also extended the deadline for start of construction of certain facilities seeking the tax credit. The Internal Revenue Service regulations on Section 45Q issued in early 2021 could provide a more stable investment environment for project planning.

Congressional interest in addressing climate change has also increased interest in CCS, though debate continues as to what role, if any, CCS should play in greenhouse gas emissions reductions. While some policymakers and other stakeholders support CCS as one option for mitigating CO₂ emissions, others raise concerns that CCS may encourage continued fossil fuel use and that CO₂

¹ See, for example, U.S. Department of Energy (DOE), National Energy Technology Laboratory (NETL), *Carbon Utilization Program*, at <https://www.netl.doe.gov/coal/carbon-utilization>.

² Formerly called Fossil Energy Research and Development.

³ Throughout this report, nominal dollars are converted to Q2 2022 dollars (referred to in this report as 2022 dollars) using the price index for federal government investment in research and development from Bureau of Economic Analysis, “National Income and Product Accounts,” Table 3.9.4.

⁴ For more information, see CRS Report R47034, *Energy and Minerals Provisions in the Infrastructure Investment and Jobs Act (P.L. 117-58)*, coordinated by Brent D. Yacobucci.

⁵ The credit is codified at 26 U.S.C. §45Q.

could leak from underground reservoirs into the air or other reservoirs, thereby negating climate benefits of CCS.⁶

This report includes a primer on the CCS (and carbon utilization) process; overviews of the DOE program for CCS R&D, U.S. Environmental Protection Agency (EPA) regulation of underground CO₂ injection used for CCS, and the Section 45Q tax credit for CO₂ sequestration; and a discussion of CCS policy issues for Congress. An evaluation of the fate of injected underground CO₂ and the permanence of CO₂ storage is beyond the scope of this report.

CCS Primer

An integrated CCS system includes three main steps: (1) capturing and separating CO₂ from other gases; (2) compressing and transporting the captured CO₂ to the sequestration site; and (3) injecting the CO₂ in subsurface geological reservoirs. The most technologically challenging and costly step in the process is the first step, carbon capture. Carbon capture equipment is capital-intensive to build and energy-intensive to operate. Power plants can supply their own energy to operate CCS equipment, but the amount of energy a power plant uses to capture and compress CO₂ is that much less electricity the plant can sell to its customers. This difference, sometimes referred to as the *energy penalty* or the *parasitic load*, has been reported to be around 20% of a power plant's capacity.⁷ **Figure 1** shows the options for parts of an integrated CCS process schematically from source to storage.

⁶ For example, the International Energy Agency (IEA) includes CCS as a “key solution” in its 2021 report on achieving global net zero greenhouse gas emissions. IEA anticipates widespread CCS deployment in several industries (e.g., power, cement, and hydrogen production) as well as direct air capture. International Energy Agency (IEA), *Net Zero by 2050: A Roadmap for the Global Energy Sector*, May 2021. See also the White House Environmental Justice Advisory Council, *Climate and Economic Justice Screening Tool and Justice 40 Interim Final Recommendations*, May 13, 2021, p. 58; and Richard Conniff, “Why Green Groups Are Split on Subsidizing Carbon Capture Technology,” *YaleEnvironment360*, April 9, 2018.

⁷ See, for example, Howard J. Herzog, Edward S. Rubin, and Gary T. Rochelle, “Comment on ‘Reassessing the Efficiency Penalty from Carbon Capture in Coal-Fired Power Plants,’” *Environmental Science and Technology*, vol. 50 (May 12, 2016), pp. 6112-6113.

Figure 1. Options for an Integrated CCS Process: Capture, Injection, and Utilization

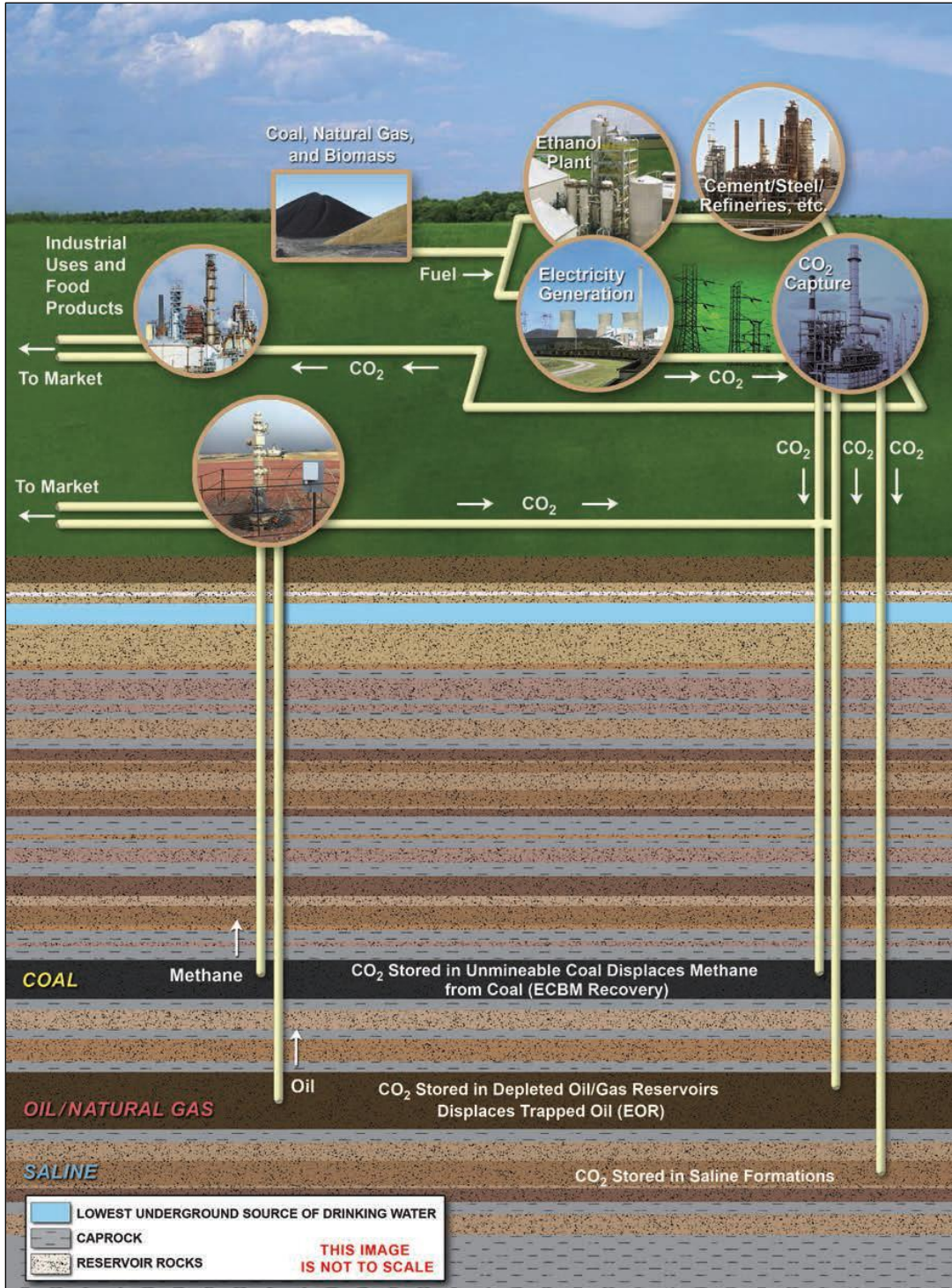

Source: U.S. Department of Energy, Office of Fossil Energy, “Carbon Utilization and Storage Atlas,” Fourth Edition, 2012, p. 4.

Notes: EOR is enhanced oil recovery; ECBM is enhanced coal bed methane recovery. *Caprock* refers to a relatively impermeable formation. Terms are explained in “CO₂ Injection and Sequestration.”

The transport and injection/storage steps of the CCS process are not technologically challenging per se, as compared to the capture step. Carbon dioxide pipelines are used for enhanced oil recovery (EOR) in regions of the United States today, and for decades large quantities of fluids have been injected into the deep subsurface for a variety of purposes, such as disposal of wastewater from oil and gas operations or of municipal wastewater.⁸ However, the transport and storage steps still face challenges, including economic and regulatory issues, rights-of-way, questions regarding the permanence of CO₂ sequestration in deep geological reservoirs, and ownership and liability issues for the stored CO₂, among others.

CO₂ Capture

The first step in CCS is to capture CO₂ at the source and separate it from other gases.⁹ As noted above, this is typically the most costly part of a CCS project, representing up to 75% of project costs in some cases.¹⁰ Current carbon capture costs are estimated at \$43-\$65 per ton CO₂ captured, though cost reductions of 50%-70% may be possible as the industry matures.¹¹

Currently, three main approaches are available to capture CO₂ from large-scale industrial facilities or power plants: (1) postcombustion capture; (2) precombustion capture; and (3) oxy-fuel combustion capture.

The following sections summarize each of these approaches. A detailed description and assessment of the carbon capture technologies is provided in CRS Report R41325, *Carbon Capture: A Technology Assessment*, by Peter Folger.

Postcombustion Capture

The process of postcombustion capture involves extracting CO₂ from the flue gas—the mix of gases produced that goes up the exhaust stack—following combustion of fossil fuels or biomass. Several commercially available technologies, some involving absorption using chemical solvents (such as an *amine*; see **Figure 2**), can in principle be used to capture large quantities of CO₂ from flue gases.¹² In a vessel called an *absorber*, the flue gas is “scrubbed” with an amine solution, typically capturing 85% to 90% of the CO₂. The CO₂-laden solvent is then pumped to a second vessel, called a *regenerator*, where heat is applied (in the form of steam) to release the CO₂. The resulting stream of concentrated CO₂ is then compressed and piped to a storage site, while the depleted solvent is recycled back to the absorber.

Other than the 2017-2020 Petra Nova project (discussed below in “Petra Nova: The First Large U.S. Power Plant with CCS”), no large U.S. commercial electricity-generating plant has been equipped with carbon capture equipment, though several projects are under development.

⁸ Injecting CO₂ into an oil reservoir often increases or enhances production by lowering the viscosity of the oil, which allows it to be pumped more easily from the formation. The process is sometimes referred to as *tertiary recovery* or *enhanced oil recovery* (EOR). EOR may involve incidental carbon storage.

⁹ Carbon capture is related to, but distinct from, direct air capture (DAC), a process that captures CO₂ from the atmosphere. DAC is discussed in more detail in later sections of this report. For a comparison of CCS and DAC, see CRS In Focus IF11501, *Carbon Capture Versus Direct Air Capture*, by Ashley J. Lawson.

¹⁰ National Petroleum Council (NPC), *Meeting the Dual Challenge: A Roadmap to At-Scale Deployment of Carbon Capture, Use, and Storage*, Chapter 5, July 17, 2020.

¹¹ Greg Kelsall, *Carbon Capture Utilisation and Storage - Status, Barriers, and Potential*, International Energy Agency (IEA) Clean Coal Centre, July 2020.

¹² *Amines* are a family of organic solvents, which can “scrub” the CO₂ from the flue gas. When the CO₂-laden amine is heated, the CO₂ is released to be compressed and stored, and the depleted solvent is recycled.

Figure 2. Diagram of Postcombustion CO₂ Capture in a Coal-Fired Power Plant Using an Amine Scrubber System

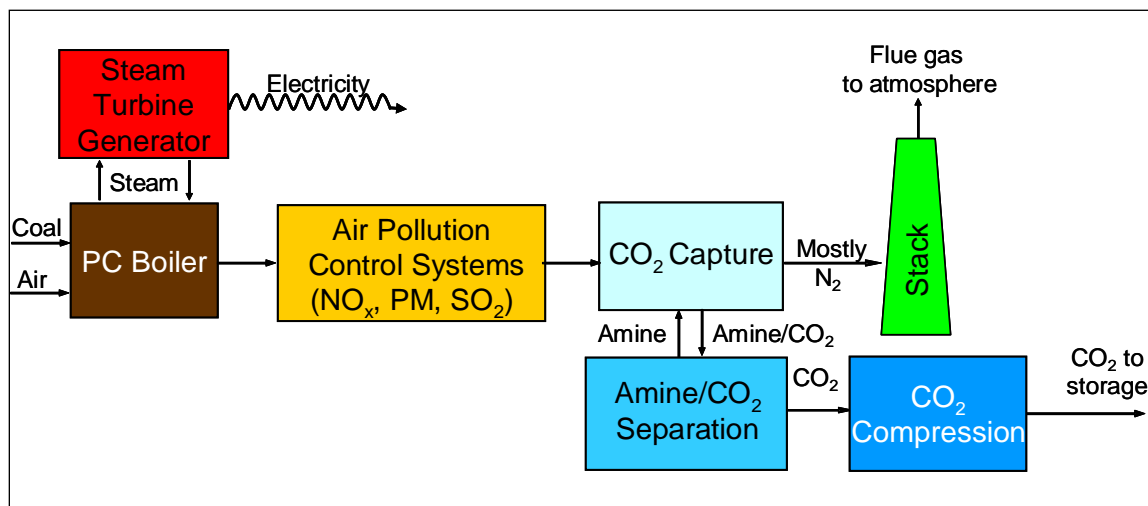

Source: E. S. Rubin, "CO₂ Capture and Transport," *Elements*, vol. 4 (2008), pp. 311-317.

Notes: Other major air pollutants (nitrogen oxides-NO_x, particulate matter-PM, and sulfur dioxide-SO₂) are removed from the flue gas prior to CO₂ capture. PC = pulverized coal. N₂ = nitrogen gas.

Precombustion Capture (Gasification)

The process of precombustion capture separates CO₂ from the fuel by combining the fuel with air and/or steam to produce hydrogen for combustion and a separate CO₂ stream that could be stored. For coal-fueled power plants, this is accomplished by reacting coal with steam and oxygen at high temperature and pressure, a process called *partial oxidation*, or *gasification* (Figure 3).¹³ The result is a gaseous fuel consisting mainly of carbon monoxide and hydrogen—a mixture known as *synthesis gas*, or *syngas*—which can be burned to generate electricity. After particulate impurities are removed from the syngas, a two-stage *shift reactor* converts the carbon monoxide to CO₂ via a reaction with steam (H₂O). The result is a mixture of CO₂ and hydrogen. A chemical solvent, such as the widely used commercial product Selexol (which employs a glycol-based solvent), then captures the CO₂, leaving a stream of nearly pure hydrogen. This is burned in a combined cycle power plant to generate electricity—known as an *integrated gasification combined-cycle plant* (IGCC)—as depicted in Figure 3. Existing IGCC power plants in the United States do not capture CO₂.¹⁴

One example of IGCC technology in operation today is the Polk Power Station about 40 miles southeast of Tampa, FL.¹⁵ The 250 megawatt (MW) unit generates electricity from coal-derived syngas produced and purified onsite. The Polk Power Station does not capture CO₂.

An example of precombustion capture technology, though not for power generation, is the Great Plains Synfuels Plant in Beulah, ND. The Great Plains plant produces synthetic natural gas from

¹³ See CRS Report R41325, *Carbon Capture: A Technology Assessment*, by Peter Folger.

¹⁴ One integrated gasification combined-cycle project in Edwardsport, IN, was designed with sufficient space to add carbon capture in the future. For further discussion, see DOE, NETL, "IGCC Project Examples," at <https://netl.doe.gov/research/coal/energy-systems/gasification/gasifipedia/project-examples>.

¹⁵ For more information about the Polk Power Station, see DOE, NETL, "Tampa Electric Integrated Gasification Combined-Cycle Project," at <https://netl.doe.gov/research/Coal/energy-systems/gasification/gasifipedia/tampa>.

lignite coal through a gasification process, and the natural gas is shipped out of the facility for sale in the natural gas market. The process also produces a stream of high-purity CO₂, which is piped northward into Canada for use in EOR at the Weyburn oil field.¹⁶

Figure 3. Diagram of Precombustion CO₂ Capture from an IGCC Power Plant

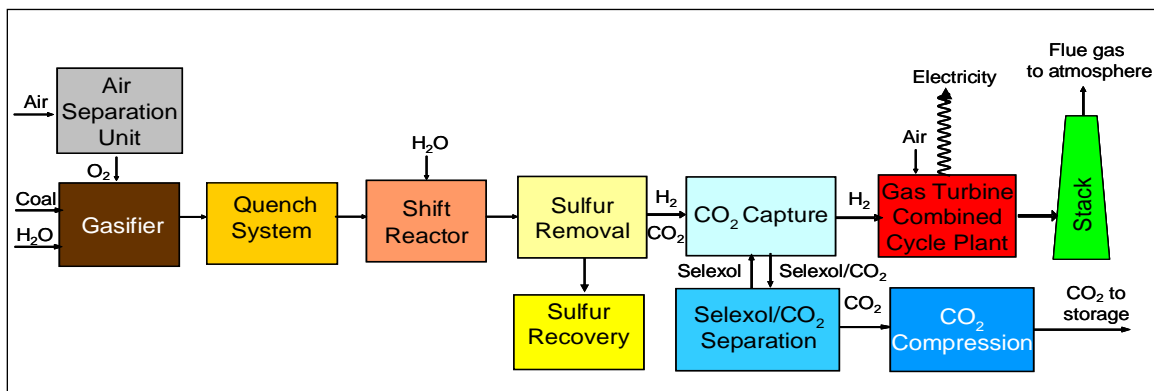

Source: E. S. Rubin, "CO₂ Capture and Transport," *Elements*, vol. 4 (2008), pp. 311-317.

Oxy-Fuel Combustion Capture

The process of oxy-fuel combustion capture uses pure oxygen instead of air for combustion and produces a flue gas that is mostly CO₂ and water, which are easily separable, after which the CO₂ can be compressed, transported, and stored (**Figure 4**). Oxy-fuel combustion requires an oxygen production step, which would likely involve a cryogenic process (shown as the air separation unit in **Figure 4**). The advantage of using pure oxygen is that it eliminates the large amount of nitrogen in the flue gas stream, thus reducing the formation of smog-forming pollutants like nitrogen oxides.

Currently oxy-fuel combustion projects are at the lab- or bench-scale, ranging up to verification testing at a pilot scale.¹⁷

¹⁶ For a more detailed description of the Great Plains Synfuels plant, see DOE, NETL, "SNG from Coal: Process & Commercialization," at <https://www.netl.doe.gov/research/coal/energy-systems/gasification/gasifipedia/great-plains>.

¹⁷ For more information, see NETL, *Oxy-Combustion*, at <https://netl.doe.gov/node/7477>.

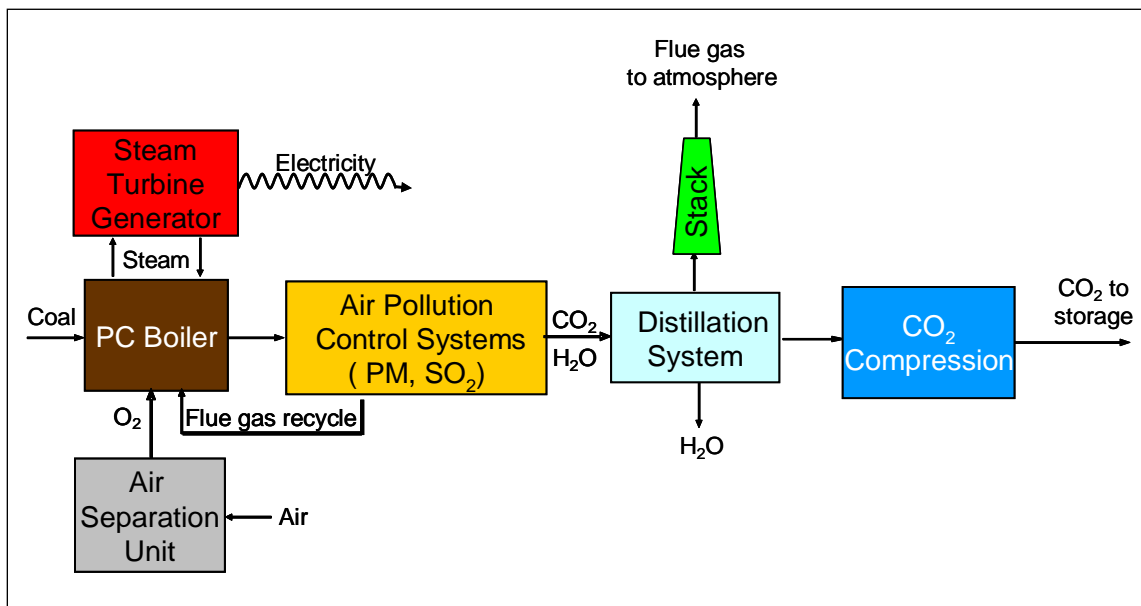
Figure 4. Diagram of Oxy-Combustion CO₂ Capture from a Coal-Fired Power Plant

Source: E. S. Rubin, "CO₂ Capture and Transport," *Elements*, vol. 4 (2008), pp. 311-317.

Allam Cycle

The Allam Cycle is a novel power plant design that uses supercritical CO₂ (sCO₂) to drive an electricity-generating turbine.¹⁸ sCO₂ is CO₂ held at certain temperature and pressure conditions, giving it unique chemical and physical properties.¹⁹ In contrast, most power plants in operation today (and most proposed power plants using CCS) use steam (i.e., water) to drive a turbine. Power plants using the Allam Cycle combust fossil fuels in pure oxygen, producing CO₂ and water.²⁰ The CO₂ can be reused multiple times to generate electricity, or piped away for utilization or storage. The excess CO₂ produced by the cycle is sufficiently pure to be directly transported or used without requiring an additional capture or purification step. For power plant operations, sCO₂ may be more efficient than steam. Initial estimates indicate that power plants using the Allam Cycle could have comparable efficiencies to natural gas combined cycle power plants without CCS.²¹

¹⁸ NET Power, *The Allam-Fetvedt Cycle*, at <https://netpower.com/the-cycle/>.

¹⁹ *Supercritical CO₂* refers to temperature and pressure conditions above a critical point where CO₂ has characteristics of both a gas and a liquid. In this "supercritical" state, small changes in temperature or pressure can result in large changes in density, which can make supercritical CO₂ a useful working fluid for power generation. The *critical point for CO₂* refers to the temperature and pressure conditions above which matter phase boundaries disappear.

²⁰ The operational NET Power facility uses natural gas as a fuel, but coal may also be used. One of the NET Power project developers, 8 Rivers Capital, received a DOE grant in 2019 to study the design of a coal-fired power plant using the Allam Cycle. DOE, "U.S. Department of Energy Invests \$7 Million for Projects to Advance Coal Power Generation Under Coal FIRST Initiative," at <https://netl.doe.gov/node/9282>.

²¹ Rodney Allam et al., "Demonstration of the Allam Cycle: An update on the development status of a high efficiency supercritical carbon dioxide power process employing full carbon capture," *Energy Procedia*, vol. 114 (2017), pp. 5948-5966.

The NET Power demonstration facility in La Porte, TX, is the first power plant to use the Allam Cycle. Plans for two commercial-scale Allam Cycle power plants—one in Colorado and one in Illinois—were announced in April 2021.²²

CO₂ Transport

After the CO₂ capture step, the gas is purified and compressed (typically into a supercritical state) to produce a concentrated stream for transport. Pipelines are the most common method for transporting CO₂ in the United States. Approximately 5,000 miles of pipelines transport CO₂ in the United States, predominantly to oil fields, where it is used for EOR.²³ Transporting CO₂ in pipelines is similar to transporting fuels such as natural gas and oil; it requires attention to design, monitoring for leaks, and protection against overpressure, especially in populated areas.

Costs for pipeline construction vary, depending upon length and capacity; right-of-way costs; whether the pipeline is onshore or offshore; whether the route crosses mountains, large rivers, or frozen ground; and other factors. The quantity and distance transported will mostly determine shipping costs. Shipping rates for CO₂ pipelines in the United States may be negotiated between the operator and shippers, or may be subject to rate regulation if they are considered open access pipelines with eminent domain authority. Siting of CO₂ pipelines is under the jurisdiction of the states, although the federal government regulates their safety.²⁴

Even though regional CO₂ pipeline networks currently operate in the United States for EOR, developing a more expansive network for CCS could pose regulatory and economic challenges. Some studies have suggested that development of a national CO₂ pipeline network that would address the broader issue of greenhouse gas emissions reduction using CCS may require a concerted federal policy, in some cases including federal incentives for CO₂ pipeline development.²⁵ In 2020, enacted legislation included provisions to facilitate the study and development of CO₂ pipelines that could be used for CCS.²⁶

Using marine vessels also may be feasible for transporting CO₂ over large distances or overseas. Liquefied natural gas and liquefied petroleum gases (i.e., propane and butane) are routinely shipped by marine tankers on a large scale worldwide.²⁷ Marine tankers transport CO₂ today, but at a small scale because of limited demand. Marine tanker costs for CO₂ shipping are uncertain, because no large-scale CO₂ transport system via vessel (in millions of metric tons of CO₂ per year, for example) is operating, although such an operation has been proposed in Europe.²⁸

²² Akshat Rathi, “U.S. Startup Plans to Build First Zero-Emission Gas Power Plants,” *Bloomberg Green*, April 15, 2021.

²³ Pipeline and Hazardous Materials Safety Administration, “Annual Report Mileage for Hazardous Liquid or Carbon Dioxide Systems,” web page, July 1, 2020, at <https://www.phmsa.dot.gov/data-and-statistics/pipeline/annual-report-mileage-hazardous-liquid-or-carbon-dioxide-systems>.

²⁴ For additional information on CO₂ pipeline safety, see CRS Insight IN11944, *Carbon Dioxide Pipelines: Safety Issues*, by Paul W. Parfomak.

²⁵ See, for example, Elizabeth Abramson et al., “Transport Infrastructure for Carbon Capture and Storage,” Regional Carbon Capture Deployment Initiative, June 2020; Ryan W. J. Edwards and Michael A. Celia, “Infrastructure to Enable Deployment of Carbon Capture, Utilization, and Storage in the United States,” *Proceedings of the National Academy of Sciences*, September 18, 2018.

²⁶ USE IT Act (H.R. 1166 and S. 383), 116th Congress, and enacted as part of P.L. 116-260.

²⁷ Rail cars and trucks also can transport CO₂, but this mode probably would be uneconomical for large-scale CCS operations.

²⁸ See IEA, “Northern Lights.”

CO₂ Injection and Sequestration

Three main types of geological formations are being considered for underground CO₂ injection and sequestration: (1) depleted oil and gas reservoirs, (2) deep saline reservoirs, and (3) unmineable coal seams. In each case, CO₂ in a supercritical state would be injected into a porous rock formation below ground that holds or previously held fluids (**Figure 1**). When CO₂ is injected at depths greater than about half a mile (800 meters) in a typical reservoir, the pressure keeps the injected CO₂ supercritical, making the CO₂ less likely to migrate out of the geological formation. The process also requires that the geological formation have an overlying *caprock* or relatively impermeable formation, such as shale, so that injected CO₂ remains trapped underground (**Figure 1**). Injecting CO₂ into deep geological formations uses existing technologies that have been primarily developed and used by the oil and gas industry and that potentially could be adapted for long-term storage and monitoring of CO₂.

The storage capacity for CO₂ when considering all the sedimentary basins in the world is potentially very large compared to total CO₂ emissions from stationary sources.²⁹ In the United States alone, DOE has estimated the total storage capacity to range between about 2.6 trillion and 22 trillion metric tons of CO₂ (see **Table 1**).³⁰ The suitability of any particular site, however, depends on many factors, including proximity to CO₂ sources and other reservoir-specific qualities such as porosity, permeability, and potential for leakage.³¹ For CCS to succeed in mitigating atmospheric emissions of CO₂, it is assumed that each reservoir type would permanently store the vast majority of injected CO₂, keeping the gas isolated from the atmosphere in perpetuity. That assumption is untested, although part of the DOE CCS R&D program has been devoted to experimenting and modeling the behavior of large quantities of injected CO₂. Theoretically—and without consideration of costs, regulatory issues, public acceptance, infrastructure needs, liability, ownership, and other issues—the United States could store its total CO₂ emissions from the electricity generating sector and other large stationary sources (at the current rate of emissions) for centuries.

Table 1. Estimates of the U.S. Storage Capacity for CO₂
(in billions of metric tons)

	Low	Medium	High
Oil and Natural Gas Reservoirs	186	205	232
Unmineable Coal	54	80	113
Saline Formations	2,379	8,328	21,633
Total	2,618	8,613	21,978

Source: U.S. Department of Energy, National Energy Technology Laboratory, *Carbon Storage Atlas*, 5th ed., August 20, 2015, at <https://www.netl.doe.gov/File%20Library/Research/Coal/carbon-storage/atlasv/ATLAS-V-2015.pdf>.

²⁹ *Sedimentary basins* refer to natural large-scale depressions in the Earth's surface that are filled with sediments and fluids and are therefore potential reservoirs for CO₂ storage.

³⁰ For comparison, in 2020 the United States emitted 1.4 billion metric tons of CO₂ from the electricity generating sector. See U.S. Environmental Protection Agency, *Inventory of U.S. Greenhouse Gas Emissions and Sinks 1990-2020*, Table 2-4, at <https://www.epa.gov/ghgemissions/inventory-us-greenhouse-gas-emissions-and-sinks-1990-2020>.

³¹ *Porosity* refers to the amount of open space in a geologic formation—the openings between the individual mineral grains or rock fragments. *Permeability* refers to the interconnectedness of the open spaces, or the ability of fluids to migrate through the formation. *Leakage* means that the injected CO₂ can migrate up and out of the intended reservoir, instead of staying trapped beneath a layer of relatively impermeable material, such as shale.

Notes: Data current as of November 2014. The estimates represent only the physical restraints on storage (i.e., the pore volume in suitable sedimentary rocks) and do not consider economic or regulatory constraints. The low, medium, and high estimates correspond to a calculated probability of exceedance of 90%, 50%, and 10%, respectively, meaning that there is a 90% probability that the estimated storage volume will exceed the low estimate and a 10% probability that the estimated storage volume will exceed the high estimate. Numbers in the table may not add precisely due to rounding.

Oil and Gas Reservoirs

Pumping water, gas, or chemical injectants into oil and gas reservoirs to boost production (that is, EOR) has been practiced in the oil and gas industry for several decades. CO₂ is one type of injectant that is used in EOR processes. The United States is a world leader in this technology, and oil and gas operators inject approximately 68 million tons of CO₂ underground each year to help recover oil and gas resources.³² Most of the CO₂ used for EOR in the United States comes from naturally occurring geologic formations, however, not from industrial sources. Using CO₂ from industrial emitters has appeal because the costs of capture and transport from the facility could be partially offset by revenues from oil and gas production. The majority of existing CCS facilities offset some of the costs by selling the captured CO₂ for EOR. According to some studies, EOR using CO₂ captured from an industrial source could potentially produce crude oil with a lower lifecycle greenhouse gas emissions intensity than either oil produced without EOR or oil produced through EOR using naturally occurring CO₂, depending on the process characteristics and analysis methodologies used.³³ CO₂ can be used for EOR onshore or offshore. To date, most U.S. CO₂ projects associated with EOR are onshore, with the bulk of activities in western Texas.³⁴ Carbon dioxide also can be injected into oil and gas reservoirs that are completely depleted, which would serve the purpose of long-term sequestration but without any offsetting financial benefit from oil and gas production.

Deep Saline Reservoirs

Some rocks in sedimentary basins contain saline fluids—brines or brackish water unsuitable for agriculture or drinking. As with oil and gas, deep saline reservoirs can be found onshore and offshore; they are often part of oil and gas reservoirs and share many characteristics. The oil industry routinely injects brines recovered during oil production into saline reservoirs for disposal.³⁵ As **Table 1** shows, deep saline reservoirs constitute the largest potential for storing CO₂ by far. However, unlike oil and gas reservoirs, storing CO₂ in deep saline reservoirs does not have the potential to enhance the production of oil and gas or to offset costs of CCS with revenues from the produced oil and gas.

³² As of 2014. See Vello Kuuskraa and Matt Wallace, “CO₂-EOR Set for Growth as New CO₂ Supplies Emerge,” *Oil and Gas Journal*, vol. 112, no. 4 (April 7, 2014), p. 66. Hereinafter Kuuskraa and Wallace, 2014.

³³ For example, one study comparing lifecycle greenhouse gas emissions of EOR using different sources of CO₂ found that using CO₂ captured from an IGCC power plant or a natural gas combined cycle power plant resulted in oil with 25%-60% lower lifecycle greenhouse gas emissions. CO₂ source is not the only determinant of the net emissions reductions associated with EOR. The types of EOR technology and methods also affect estimated emissions reductions in scientific studies. To a certain extent, EOR can be optimized for CO₂ storage (i.e., conducted in such a way as to attempt to maximize the storage of CO₂ as opposed to maximizing the production of oil).

³⁴ As of 2014, nearly two-thirds of oil production using CO₂ for EOR came from the Permian Basin, located in western Texas and southeastern New Mexico. Kruskaa and Wallace, 2014, p. 67.

³⁵ The U.S. Environmental Protection Agency (EPA) regulates this practice under authority of the Safe Drinking Water Act, Underground Injection Control (UIC) program. See the EPA UIC program at <https://www.epa.gov/uic/class-ii-oil-and-gas-related-injection-wells>.

Unmineable Coal Seams

U.S. coal resources that are not mineable with current technology are those in which the coal beds are not thick enough, are too deep, or lack structural integrity adequate for mining.³⁶ Even if they cannot be mined, coal beds are commonly permeable and can trap gases, such as methane, which can be extracted (a resource known as *coal-bed methane*, or CBM). Methane and other gases are physically bound (adsorbed) to the coal. Studies indicate that CO₂ binds to coal even more tightly than methane binds to coal.³⁷ CO₂ injected into permeable coal seams could displace methane, which could be recovered by wells and brought to the surface, providing a source of revenue to offset the costs of CO₂ injection. Unlike EOR, injecting CO₂ and displacing, capturing, and selling CBM (a process known as *enhanced coal bed methane recovery*, or ECBM) to offset the costs of CCS is not part of commercial production. Currently, nearly all CBM is produced by removing water trapped in the coal seam, which reduces the pressure and enables the release of the methane gas from the coal.

Carbon Utilization

The concept of carbon utilization has gained increasingly widespread interest within Congress and in the private sector as a means for capturing CO₂ and storing it in potentially useful and commercially viable products, thereby reducing emissions to the atmosphere and offsetting the cost of CO₂ capture. EOR is currently the main use of captured CO₂, and some observers envision EOR will continue to dominate carbon utilization for some time, supporting the scale-up of capture technologies that could later rely upon other utilization pathways.³⁸ Nonetheless, research activities and congressional interest in utilization tend to focus on uses other than EOR. For example, P.L. 115-123, the Bipartisan Budget Act of 2018, which expanded the Section 45Q tax credit for carbon capture and sequestration, excludes EOR from the definition of carbon utilization. P.L. 115-123 defines carbon utilization as³⁹

- the fixation of such qualified carbon oxide through photosynthesis or chemosynthesis, such as through the growing of algae or bacteria;
- the chemical conversion of such qualified carbon oxide to a material or chemical compound in which such qualified carbon oxide is securely stored; and
- the use of such qualified carbon oxide for any other purpose for which a commercial market exists (with the exception of use as a tertiary injectant in a qualified enhanced oil or natural gas recovery project), as determined by the Secretary [of the Treasury].⁴⁰

P.L. 116-260 provides two authorizations for a DOE carbon utilization research program (to be coordinated as a single program) in the USE IT Act and Energy Act of 2020. Both focus on

³⁶ *Coal bed* and *coal seam* are interchangeable terms.

³⁷ IPCC Special Report, p. 217.

³⁸ For example, “For good reasons, many seek to find ways to use CO₂ to create economic value in a climate-positive way. Today, the primary use of CO₂ is for enhanced oil recovery. This is an important near-term pathway and provides opportunities to finance projects, scale-up technologies and reduce costs.” Written testimony of Dr. S. Julio Friedmann, U.S. Congress, Senate Committee on Energy and Natural Resources, *Full Committee Hearing to Examine Development and Deployment of Large-Scale Carbon Dioxide Management Technologies*, 116th Cong., 2nd sess., July 28, 2020.

³⁹ CRS In Focus IF11455, *The Tax Credit for Carbon Sequestration (Section 45Q)*, by Angela C. Jones and Molly F. Sherlock.

⁴⁰ P.L. 115-123, §41119. A *tertiary injectant* refers to the use of CO₂ for EOR or enhanced natural gas recovery.

“novel uses” for carbon and CO₂, such as “chemicals, plastics, building materials, fuels, cement, products of coal utilization in power systems or in other applications, and other products with demonstrated market value.”⁴¹

Figure 5 illustrates an array of potential utilization pathways: uptake using algae (for biomass production), conversion to fuels and chemicals, mineralization into inorganic materials, and use as a working fluid (e.g., for EOR) or other services.

Figure 5. Schematic Illustration of Current and Potential Uses of CO₂

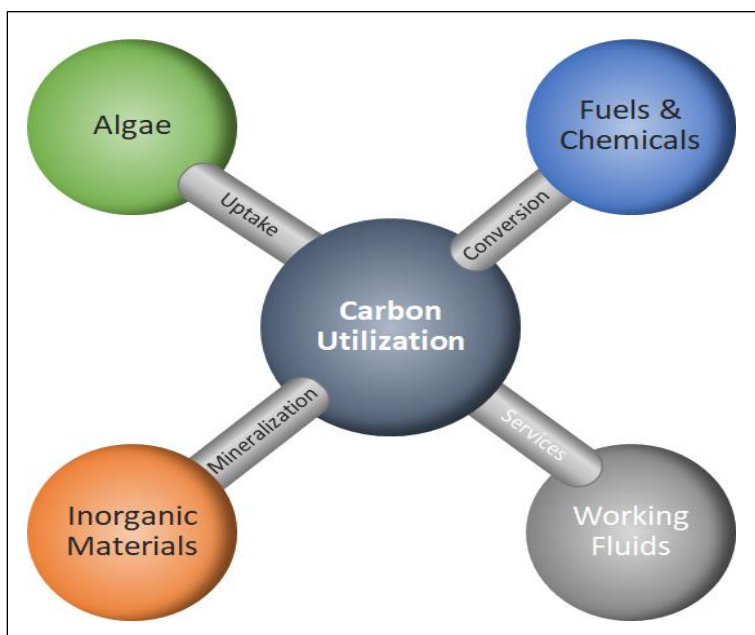

Source: U.S. DOE, National Energy Technology Laboratory (NETL), at <https://www.netl.doe.gov/coal/carbon-utilization>.

⁴¹ P.L. 116-260, Division S, §102(c).

Direct Air Capture

Direct air capture (DAC) is an emerging set of technologies that aim to remove CO₂ directly from the atmosphere, as opposed to the point source capture of CO₂ from a source like a power plant (as described above in “CO₂ Capture”).⁴²

DAC systems typically employ a chemical capture system to separate CO₂ from ambient air, add energy to separate the captured CO₂ from the chemical substrate, and remove the purified CO₂ to be stored permanently or utilized for other purposes.⁴³ This process is similar to postcombustion carbon capture in some ways, though DAC and CCS differ in a number of ways.

DAC systems have the potential to be classified as net carbon negative, meaning that if the captured CO₂ is permanently sequestered or becomes part of long-lasting products such as cement or plastics, the end result would be a reduction in the atmospheric concentration of CO₂. In addition, DAC systems can be sited almost anywhere—they do not need to be near power plants or other point sources of CO₂ emissions. They could be located, for example, close to manufacturing plants that require CO₂ as an input, and would not necessarily need long pipeline systems to transport the captured CO₂.

The concentration of CO₂ in ambient air is far lower than the concentration found at most point sources. Thus, a recognized drawback of DAC systems is their high cost per ton of CO₂ captured, compared to the more conventional CCS technologies.⁴⁴ A 2011 assessment estimated costs at roughly \$600 per ton of captured CO₂.⁴⁵ A more recent assessment from one of the companies developing DAC technology, however, projects lower costs for commercially deployed plants of between \$94 and \$232 per ton.⁴⁶ In 2021, DOE launched a research effort called the Carbon Negative Shot, aiming to achieve CO₂ removal (including DAC) for less than \$100 per ton.⁴⁷ By comparison, some estimate costs for conventional CCS from coal-fired electricity generating plants in the United States between \$48 and \$109 per ton.⁴⁸

Congress has sometimes combined support for CCS and DAC into single proposals, despite the differences in the technologies. For example, the federal tax credit for carbon sequestration applies to CCS and DAC projects (with CO₂ injection for sequestration).⁴⁹ In other cases, though, Congress has treated the technologies separately. For example, the Energy Act of 2020 provided CCS R&D authorizations primarily in Title IV—Carbon Management, while most DAC R&D authorizations are in Title V—Carbon Removal.

⁴² CRS In Focus IF11501, *Carbon Capture Versus Direct Air Capture*, by Ashley J. Lawson. Some processes capture CO₂ from seawater instead of the atmosphere. These are sometimes called *direct ocean capture*, or *DOC*.

⁴³ For a detailed assessment of DAC technology, see the American Physical Society, *Direct Air Capture of CO₂ with Chemicals: A Technology Assessment for the APS Panel on Public Affairs*, June 1, 2011, at <https://www.aps.org/policy/reports/assessments/upload/dac2011.pdf>. Hereinafter American Physical Society, 2011. Additional background information is also available in National Academies of Sciences, Engineering, and Medicine, *Negative Emissions Technologies and Reliable Sequestration: A Research Agenda*, 2019.

⁴⁴ Generally, the more dilute the concentration of CO₂, the higher the cost to extract it, because much larger volumes are required to be processed. By comparison, the concentration of CO₂ in the atmosphere is about 0.04%, whereas the concentration of CO₂ in the flue gas of a typical coal-fired power plant is about 14%. Duncan Leeson, Andrea Ramirez, and Niall Mac Dowell, “Carbon Capture and Storage from Industrial Sources,” in *Carbon Capture and Storage*, ed. Mai Bui and Niall Mac Dowell, p. 299.

⁴⁵ American Physical Society, 2011, p. 13.

⁴⁶ Robert F. Service, “Cost Plunges for Capturing Carbon Dioxide from the Air,” *Science*, June 7, 2018, at <http://www.sciencemag.org/news/2018/06/cost-plunges-capturing-carbon-dioxide-air>.

⁴⁷ DOE, “Secretary Granholm Launches Carbon Negative Earthshots to Remove Gigatons of Carbon Pollution From the Air by 2050,” press release, November 5, 2021.

⁴⁸ Lawrence Irlam, *The Costs of CCS and Other Low-Carbon Technologies in the United States-2015 Update*, Global CCS Institute, July 2015, p. 1, at <http://www.globalccsinstitute.com/publications/costs-ccs-and-other-low-carbon-technologies-2015-update>.

⁴⁹ For more information, see CRS In Focus IF11455, *The Tax Credit for Carbon Sequestration (Section 45Q)*, by Angela C. Jones and Molly F. Sherlock.

Commercial CCS Facilities

According to one set of data collected by the Global CCS Institute (GCCSI), 24 commercial facilities were capturing and injecting CO₂ throughout the world in 2021, 12 of which are in the United States.⁵⁰ An additional facility, the Red Trail Energy facility, came online in the United States in 2022. See **Figure 6** for locations of U.S. projects capturing and injecting CO₂ for either EOR or geologic sequestration, some of which are not in operation.

Figure 6. Location of U.S. Carbon Capture and Injection Projects

EOR and Geologic Sequestration

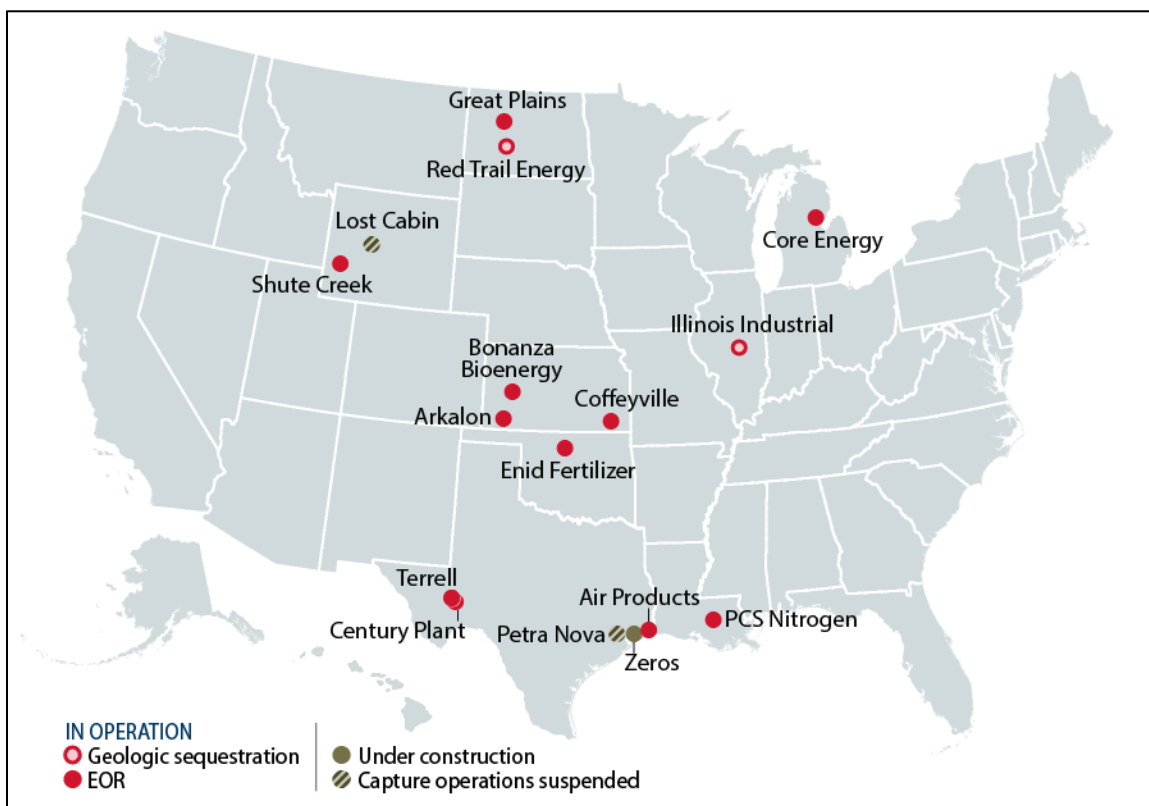

Source: CRS, using data from the Global CCS Institute, *Global Status Report 2021*, 2021, and the University of North Dakota Energy & Environment Research Center at undeerc.org.

⁵⁰ Global CCS Institute, *Global Status Report 2021*, December 1, 2021; and North Dakota Industrial Commission, *Class VI - Geologic Sequestration Wells*, accessed October 4, 2022, at <https://www.dmr.nd.gov/dmr/oilgas/ClassVI>. The 13 facilities in operation do not include two facilities, Petra Nova and Lost Cabin, that stopped CCS operations in 2020, or the Zeros facility, which is under construction. The Global CCS Institute defines a *commercial facility* as a facility capturing CO₂ for permanent storage as part of an ongoing commercial operation that generally has an economic life similar to the host facility whose CO₂ it captures, and that supports a commercial return while operating and/or meets a regulatory requirement.

These facilities reportedly have a cumulative capacity to capture an estimated 40 million metric tons of CO₂ each year.⁵¹ Additionally, according to GCCSI, one commercial facility was under construction and 15 projects were in advanced development in the United States, as of 2021.⁵²

U.S. capture and injection facilities in operation or under development occur in seven industrial sectors, according to GCCSI data: chemical production, hydrogen production, fertilizer production, natural gas processing, and power generation.⁵³ Until spring of 2022, the Archer Daniels Midland (ADM) facility in Decatur, IL (also known as the Illinois Industrial Project), was the only facility injecting CO₂ solely for geologic sequestration. The facility injects CO₂ captured from ethanol production into a saline reservoir and as of 2021 reported that 2 million metric tons of CO₂ had been injected at the site.⁵⁴ In 2022, North Dakota issued a Class VI permit for CO₂ injection by Red Trail Energy in Richardton, ND. The company plans to capture and inject 180,000 tons of CO₂ per year into an on-site formation for geologic sequestration.⁵⁵ See **Figure 7** for additional information on the timeline and industrial sectors for CO₂ capture and injection facilities in the United States.

⁵¹ Global CCS Institute, *Global Status Report 2021*, p. 62.

⁵² Global CCS Institute, *Global Status Report 2021*, pp. 63-64. GSSCI does not define “advanced development” in this report.

⁵³ Global CCS Institute, *Global Status Report 2020*. “Under development” indicates that some project development activity has occurred (e.g., feasibility or design studies), but the facility is not actively capturing and/or injecting CO₂. Projects may be in different stages of development.

⁵⁴ EPA FLIGHT database, accessed March 14, 2022.

⁵⁵ Industrial Commission of North Dakota, “North Dakota Approves First Carbon Capture and Storage Project Under State Primacy in the United States,” accessed August 1, 2022, at www.nd.gov/ndic/ic-press/News-DMR211019.pdf.

Figure 7. Operational, Planned, and Suspended Facilities in the United States Injecting CO₂ for Geologic Sequestration and EOR

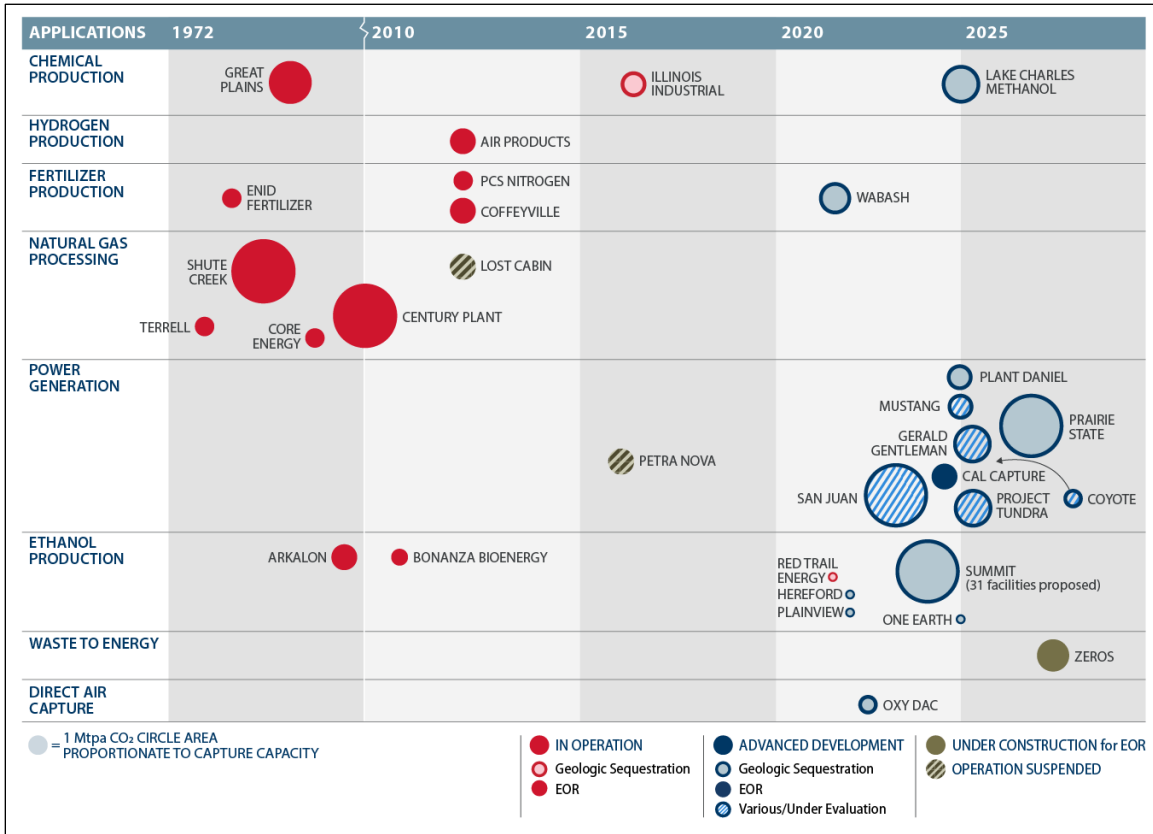

Source: CRS, adapted from Global CCS Institute, *Global Status Report 2021*, 2021; GSSCI does not define “advanced development” in this report. Red Trail Energy information from the Industrial Commission of North Dakota.

Notes: Mtpa = million tons per annum (year); circle placement indicates initial year of operations or anticipated initial year of operations for projects under development, according to GCCSI (the first time frame in the figure represents 38 years, while the other time frames each represent a five-year period). Some projects under development anticipate multiple CO₂ sources; in these cases, circle placement indicates the initial application being studied.

Stakeholders have paid particular attention to two power generation projects: Boundary Dam, in Saskatchewan, Canada, and Petra Nova, near Houston, TX. Both projects involved retrofitting coal-fired electricity generators with carbon capture equipment and have been noted as examples of carbon capture technology. At the same time, both projects have been criticized for high costs, relative to other low-carbon technologies for electricity generation, and for sequestering carbon via EOR.⁵⁶ In May 2020, Petra Nova’s owners stopped operating the CCS equipment, citing unfavorable economics due to low crude oil prices, though reports suggest the facility may have experienced prior mechanical challenges.⁵⁷

⁵⁶ See, for example, Food & Water Watch, “Top 5 Reasons Carbon Capture and Storage (CCS) Is Bogus,” July 20, 2021.

⁵⁷ Jeremy Dillon and Carlos Anchondo, “Low Oil Prices Force Petra Nova Into ‘Mothball Status,’” *E&E News*, July 28, 2020; and Nichola Groom, “Problems Plagued U.S. CO₂ Capture Project Before Shutdown: DOE Document,” Reuters, August 6, 2020.

Petra Nova: The First Large U.S. Power Plant with CCS

On January 10, 2017, the Petra Nova–W.A. Parish Generating Station became the first industrial-scale coal-fired power plant with CCS to operate in the United States. The plant began capturing 5,200 short tons (approximately 4,717 metric tons) of CO₂ per day from its 240-megawatt-equivalent slipstream using post combustion capture technology.⁵⁸ The capture technology was designed to be approximately 90% efficient (i.e., designed to capture about 90% of the CO₂ in the exhaust gas after the coal was burned to generate electricity) and was designed to capture 1.4 million metric tons of CO₂ each year.⁵⁹ The captured CO₂ was transported via an 82-mile pipeline to the West Ranch oil field, where it was injected for EOR. NRG Energy Inc., and JX Nippon Oil & Gas Exploration Corporation, the joint owners of the Petra Nova project, together with Hilcorp Energy Company (which handled the injection and EOR), anticipated increasing West Ranch oil production from 300 barrels per day before EOR to 15,000 barrels per day after EOR.⁶⁰ However, Petra Nova’s operators turned off the CCS equipment in May 2020, citing low oil prices caused, in part, by the COVID-19 pandemic.⁶¹ In January 2021, the operators announced plans to indefinitely shut down the CCS equipment’s power source.⁶² As of October 2022, Petra Nova remains out of service.⁶³

DOE provided Petra Nova with more than \$160 million from its Clean Coal Power Initiative (CCPI) Round 3 funding, using funds appropriated under the American Recovery and Reinvestment Act of 2009 (ARRA; P.L. 111-5) together with other DOE funding for a total of more than \$190 million of federal funds for the \$1 billion retrofit project.⁶⁴ Petra Nova is the only CCPI Round 3 project that expended its ARRA funding and began operating.⁶⁵ The three other CCPI Round 3 demonstration projects funded using ARRA appropriations (as well as the FutureGen project—slated to receive nearly \$1 billion in ARRA appropriations) all have been canceled, have been suspended, or remain in development.⁶⁶

⁵⁸ Slipstream refers to the exhaust gases emitted from the power plant. U.S. Department of Energy (DOE), *W.A. Parish Post-Combustion CO₂ Capture and Sequestration Demonstration Project Final Scientific/Technical Report*, March 31, 2020, p. 3.

⁵⁹ DOE, “Petra Nova CCS Project.”

⁶⁰ NRG News Release, “NRG Energy, JX Nippon Complete World’s Largest Post-Combustion Carbon Capture Facility On-Budget and On-Schedule,” January 10, 2017, at <http://investors.nrg.com/phoenix.zhtml?c=121544&p=irol-newsArticle&ID=2236424>.

⁶¹ L.M.Sixel, “NRG Mothballs Carbon Capture Project at Coal Plant,” *Houston Chronicle*, July 31, 2020.

⁶² “Power Plant Linked to Idled U.S. Carbon Capture Project Will Shut Indefinitely,” Reuters, January 29, 2021, <https://finance.yahoo.com/news/power-plant-linked-idled-u-204526410.html>.

⁶³ Corbin Hiar and Carlos Anchondo, “Biggest CCS Failure Clouds Supreme Court Ruling,” E&E News, July 11, 2022.

⁶⁴ U.S. Department of Energy (DOE), National Energy Technology Laboratory (NETL), “Recovery Act: Petra Nova Parish Holdings: W.A. Parish Post-Combustion CO₂ Capture and Sequestration Project,” at <https://www.netl.doe.gov/research/coal/project-information/fe0003311>.

⁶⁵ For an analysis of carbon capture and sequestration (CCS) projects funded by the American Recovery and Reinvestment Act (P.L. 111-5), see CRS Report R44387, *Recovery Act Funding for DOE Carbon Capture and Sequestration (CCS) Projects*, by Peter Folger.

⁶⁶ FutureGen is discussed in more detail in CRS Report R44387, *Recovery Act Funding for DOE Carbon Capture and Sequestration (CCS) Projects*, by Peter Folger.

Boundary Dam: World's First Addition of CCS to a Large Power Plant

The Boundary Dam project was the first commercial-scale power plant with CCS in the world to begin operations. Boundary Dam, a Canadian venture operated by SaskPower,⁶⁷ cost approximately \$1.5 billion, according to one source, though it was originally estimated to cost \$1.3 billion.⁶⁸ Of the originally estimated amount, \$800 million was for building the CCS process and the remaining \$500 million was for retrofitting the Boundary Dam Unit 3 coal-fired generating unit. The project also received \$240 million from the Canadian federal government. Boundary Dam started operating in October 2014, after a four-year construction and retrofit of the 150-megawatt generating unit. The final project was smaller than earlier plans to build a 300-megawatt CCS plant, but that original idea may have been projected to cost as much as \$3.8 billion. The larger-scale project was discontinued because of the escalating costs.⁶⁹

Boundary Dam captures, transports, and sells most of its CO₂ for EOR, shipping 90% of the captured CO₂ via a 41-mile pipeline to the Weyburn Field in Saskatchewan. CO₂ not sold for EOR is injected and stored about 2.1 miles underground in a deep saline aquifer at a nearby experimental injection site. By March 2022, the plant had captured over 4.3 million metric tons of CO₂ since full-time operations began in October 2014.⁷⁰ The project injected 370,000 metric tons of CO₂ for geologic sequestration as of 2021.⁷¹

The DOE CCS Program

DOE has funded R&D of aspects of the three main steps of an integrated CCS system since at least 1997, primarily through its Fossil Energy and Carbon Management Research, Development, Demonstration, and Deployment program (FECM).⁷² CCS-focused R&D has come to dominate the coal program area within DOE FECM since 2010. Since FY2010, Congress has provided \$9.2 billion (in constant 2022 dollars) total in annual appropriations for FECM (see **Table 2**).⁷³

⁶⁷ SaskPower is the principal electric utility in Saskatchewan, Canada.

⁶⁸ MIT Carbon Capture & Sequestration Technologies, CCS Project Database, “Boundary Dam Fact Sheet: Carbon Capture and Storage Project,” at http://sequestration.mit.edu/tools/projects/boundary_dam.html.

⁶⁹ Ibid.

⁷⁰ SaskPower, *BD3 Status Update: March 2022*, at <https://www.saskpower.com/about-us/our-company/blog/2022/bd3-status-update-march-2022>.

⁷¹ Petroleum Technology Research Center, *Annual Report 2020-2021*, at https://ptrc.ca/pub/docs/annual-reports/Annual%20Report%202020-21-%20Final_sm.pdf.

⁷² DOE has also funded some CCS and carbon removal research through its Advanced Research Projects Agency – Energy. The Fossil Energy and Carbon Management Research, Development, Demonstration, and Deployment appropriations account was previously known as the Fossil Energy Research and Development (FER&D) account. The Biden Administration renamed the Office of Fossil Energy as the Office of Fossil Energy and Carbon Management in 2021. This name change was also adopted by appropriators throughout the FY2022 appropriations process. See DOE, “Our New Name Is Also a New Vision,” July 8, 2021, at <https://www.energy.gov/fe/articles/our-new-name-also-new-vision>.

⁷³ For information on FY2021 and FY2022 appropriations, see CRS In Focus IF11861, *DOE's Carbon Capture and Storage (CCS) and Carbon Removal Programs*, by Ashley J. Lawson.

Table 2. Annual Appropriations for DOE Fossil Energy and Carbon Management (FECM) Research, Development, Demonstration, and Deployment Program Areas

FY2010 through FY2022 (in thousands of nominal dollars)

FECM Program Areas	Program/Activity	FY2010	FY2011	FY2012	FY2013	FY2014	FY2015	FY2016	FY2017	FY2018	FY2019	FY2020	FY2021	FY2022	
CCUS and Power Systems	Carbon Capture	—	58,703	66,986	63,725	92,000	88,000	101,000	101,000	100,671	100,671	117,800	86,300	99,000	
	Carbon Dioxide Removal												40,000	49,000	
	Carbon Utilization												23,000	29,000	
	Carbon Storage	—	120,912	112,208	106,745	108,766	100,000	106,000	95,300	98,096	98,096	100,000	79,000	97,000	
	Advanced Energy and Hydrogen Systems	—	168,627	97,169	92,438	99,500	103,000	105,000	105,000	112,000	129,683	120,000	108,100	94,000	
	Cross-Cutting Research	—	41,446	47,946	45,618	41,925	49,000	50,000	45,500	58,350	56,350	56,000	32,900	33,000	
	Mineral Sustainability	—	—	—	—	—	—	—	—	—	—	—	—	53,000	53,000
	Supercritical CO ₂ Technology	—	—	—	—	—	10,000	15,000	24,000	24,000	22,430	16,000	14,500	15,000	
	NETL Coal R&D	—	—	35,011	33,338	50,011	50,000	53,000	53,000	53,000	54,000	61,000	0		
	Transformational Coal Pilots ^a	—	—	—	—	—	—	—	—	50,000 ^a	35,000	25,000	20,000	10,000	0
Subtotal CCUS and Power Systems		393,485	389,688	359,320	341,864	392,202	400,000	430,000	473,800	481,117	486,230	490,800	446,800	469,000	
Other FECM	Natural Gas Technologies	17,364	0	14,575	13,865	20,600	25,121	43,000	43,000	50,000	51,000	51,000	57,000	0	

FECM Program Areas	Program/Activity	FY2010	FY2011	FY2012	FY2013	FY2014	FY2015	FY2016	FY2017	FY2018	FY2019	FY2020	FY2021	FY2022
	Unconventional Fossil Energy Technologies from Petroleum – Oil Technologies	19,474	0	4,859	4,621	15,000	4,500	20,321	21,000	40,000	46,000	46,000	46,000	0
	Resource Technologies and Sustainability													110,000
	Program Direction	158,000	164,725	119,929	114,201	120,000	119,000	114,202	60,000	60,000	61,070	61,500	61,500	66,800
	Plant and Capital	20,000	19,960	16,794	15,982	16,032	15,782	15,782	—	—	—	—	—	—
	Env. Restoration	10,000	9,980	7,897	7,515	5,897	5,897	7,995	—	—	—	—	—	—
	Special Recruitment	700	699	700	667	700	700	700	700	700	700	700	700	1,001
	NETL Research and Operations	—	—	—	—	—	—	0	43,000	50,000	50,000	50,000	83,000	83,000
	NETL Infrastructure	—	—	—	—	—	—	0	40,500	45,000	45,000	50,000	55,000	75,000
	Coop R&D	4,868	—	—	—	—	—	—	—	—	—	—	—	—
	Directed Projects	35,879	—	—	—	—	—	—	—	—	—	—	—	20,199
Subtotal Other FECM		266,285	195,364	164,754	156,851	178,229	171,000	202,000	208,200	245,700	253,770	259,200	303,200	356,000
Rescissions/Use of Prior-Year Balances		—	(151,000)	(187,000)	—	—	—	—	(14,000)	—	—	—	—	—
Total FECM		659,770	434,052	337,074	498,715	570,431	571,000	632,000	668,000	726,817	740,000	750,000	750,000	825,000
Total FECM (Q2 2022 dollars)		832,547	533,715	409,144	598,581	669,712	669,402	740,721	766,636	809,515	809,032	800,863	781,295	825,000

Sources: U.S. Department of Energy annual budget justifications for FY2012 through FY2023; explanatory statement for P.L. 115-141, Division D (Consolidated Appropriations Act, 2018, at <https://rules.house.gov/bill/115/hr-1625-sa>); explanatory statement for P.L. 117-30 (Consolidated Appropriations Act, 2022, Division D).

Notes: CO₂ = carbon dioxide; CCUS = carbon capture utilization and sequestration (or storage); FECM = Fossil Energy and Carbon Management Research, Development, Demonstration, and Deployment program; NETL = National Energy Technology Laboratory; Inf. & Ops = infrastructure and operations; Coop = cooperative; R&D = research and development. Directed Projects refer to congressionally directed projects. Program areas are as used in the explanatory statement for FY2022 appropriations; previous appropriations language used alternative names for some program areas and may not be completely comparable. Supplemental appropriations provided by the American Recovery and Reinvestment Act of 2009 (ARRA; P.L. 111-5) and the Infrastructure Investment and Jobs Act (IIJA; P.L. 117-58) are not shown in the table. The carbon utilization program was first authorized for FY2021 as part of P.L. 116-260. The line items for Carbon Dioxide Removal and Resource Technologies and Sustainability were first used in FY2022 appropriations. Nominal dollars adjusted to Q2 2022 dollars using the price index for federal government investment in research and development from Bureau of Economic Analysis, “National Income and Product Accounts,” Table 3.9.4.

- a. Funding for Transformational Coal Pilots was first provided as a proviso in FY2017 appropriations. See explanatory statement for P.L. 115-31, Consolidated Appropriations Act, 2017, Division D at <https://www.gpo.gov/fdsys/pkg/CPRT-115HPRT25289/pdf/CPRT-115HPRT25289.pdf>.

Congress has additionally provided supplemental funding for DOE’s CCS activities. The American Recovery and Reinvestment Act of 2009 (ARRA; P.L. 111-5) provided an additional \$3.4 billion (\$4.4 billion in 2022 dollars), specifically for CCS projects.⁷⁴ The Infrastructure Investment and Jobs Act (IIJA; P.L. 117-58) provided \$8.5 billion (nominal dollars) in supplemental funding for CCS for FY2022-FY2026 (see **Table 3**), including funding for the construction of new carbon capture facilities and commercial carbon storage facilities. Additionally, IIJA provided \$3.6 billion (nominal dollars) in supplemental funding for DAC, primarily to support the establishment of four regional direct air capture hubs in the United States.⁷⁵

Table 3. Infrastructure Investment and Jobs Act Supplemental Appropriations for Carbon Capture and Storage Programs

FY2022 through FY2026 (in thousands of nominal dollars)

Program	Unspecified Year	FY2022	FY2023	FY2024	FY2025	FY2026	Total FY2022-FY2026
Front-End Engineering and Design (carbon capture)		20,000	20,000	20,000	20,000	20,000	100,000
Carbon Capture Large-Scale Pilot Projects		387,000	200,000	200,000	150,000	—	937,000
Carbon Capture Demonstration Projects		937,000	500,000	500,000	600,000	—	2,537,000
Carbon Dioxide Transportation Infrastructure Finance and Innovation (CIFIA)		3,000	2,097,000	—	—	—	2,100,000
Carbon Utilization		41,000	65,250	66,563	67,941	69,388	310,141
Carbon Storage Validation and Testing		500,000	500,000	500,000	500,000	500,000	2,500,000
U.S. Environmental Protection Agency Class VI Injection Well Program	50,000	5,000	5,000	5,000	5,000	5,000	75,000

Source: Infrastructure Investment and Jobs Act (IIJA; P.L. 117-58), Division J.

⁷⁴ Authority to expend American Recovery and Reinvestment Act (ARRA; P.L. 111-5) funds expired in 2015. An analysis of ARRA funding for CCS activities at DOE is provided in CRS Report R44387, *Recovery Act Funding for DOE Carbon Capture and Sequestration (CCS) Projects*, by Peter Folger.

⁷⁵ The Infrastructure Investment and Jobs Act (IIJA; P.L. 117-58) defined a regional direct air capture hub as “a network of direct air capture projects, potential carbon dioxide utilization off-takers, connective carbon dioxide transport infrastructure, subsurface resources, and sequestration infrastructure located within a region.” 42 U.S.C. §16298d(j).

Notes: Programs are within the U.S. Department of Energy (DOE), except for the U.S. Environmental Protection Agency's (EPA's) Class VI injection well program, which permits wells for geological sequestration of carbon dioxide. Some DOE programs are administered by the Office of Fossil Energy and Carbon Management (FECM), while others are administered by the Office of Clean Energy Demonstrations. IIJA additionally provided \$3,500,000,000 (\$700 million each year, FY2022-FY2026) to develop four regional clean direct air capture hubs and \$115 million (unspecified year) for direct air capture technology prize competitions. Both programs are to be administered by FECM. All funds are to remain available until expended.

A 2021 evaluation by the Government Accountability Office (GAO) found several cost control risks related to DOE's past management of its CCS program, particularly DOE's implementation of ARRA.⁷⁶ These risks included a high-risk selection process, an accelerated schedule of project review, and the bypassing of internal cost controls. GAO found DOE used less risky processes in awarding CCS funding for industrial projects as compared to coal projects. Partly as a result, two out of three funded industrial CCS projects were operational in 2021, while none of the eight funded coal projects was operational. GAO noted that economic factors, such as declines in natural gas prices, affected coal projects more than industrial projects, and also contributed to withdrawal or cancellation of DOE-funded coal projects.

EPA Regulation of Underground Injection in CCS

EPA issues regulations for underground injection of CO₂ as part of its responsibilities for underground injection control (UIC) programs under the Safe Drinking Water Act (SDWA). EPA also develops guidance to support state program implementation, and in some cases, directly administers UIC programs in states.⁷⁷ The agency has established minimum requirements for state UIC programs and permitting for injection wells. These requirements include performance standards for well construction, operation and maintenance, monitoring and testing, reporting and recordkeeping, site closure, financial responsibility, and, for some types of wells, post injection site care. Most states implement the day-to-day program elements for most categories of wells, which are grouped into "classes" based on the type of fluid injected. Owners or operators of underground injection wells must follow the permitting requirements and standards established by the UIC program authority in their state.

EPA has issued regulations for six classes of underground injection wells based on type and depth of fluids injected and potential for endangerment of underground sources of drinking water (USDWs). Class II wells are used to inject fluids related to oil and gas production, including injection of CO₂ for EOR. There are more than 119,500 EOR wells in the United States, predominantly in California, Texas, Kansas, Illinois, and Oklahoma.⁷⁸ This total includes EOR wells that can be used to inject CO₂ captured from anthropogenic sources and wells using naturally derived CO₂. Class VI wells are used to inject CO₂ for geologic sequestration. Two EPA-permitted Class VI wells are currently operating for sequestration in the United States, both located at the ADM facility in Illinois.⁷⁹ In 2022, North Dakota, which has delegated authority for its UIC Class VI well program, issued two CO₂ injection permits for geologic sequestration.

⁷⁶ U.S. Government Accountability Office, *Carbon Capture and Storage: Actions Needed to Improve DOE Management of Demonstration Projects*, December 2021.

⁷⁷ 40 C.F.R. §§144-147.

⁷⁸ EPA, *FY19 State UIC Injection Well Inventory*, accessed April 11, 2021.

⁷⁹ EPA has granted North Dakota and Wyoming primary enforcement authority for Class VI well programs in those states.

To protect USDWs from injected CO₂ or movement of other fluids in an underground formation, Class II EOR wells must transition to Class VI geologic sequestration wells under certain conditions.⁸⁰ Class II well owners or operators who inject CO₂ primarily for long-term storage (rather than oil production) must obtain a Class VI permit when there is an increased risk to USDWs compared to prior Class II operations using CO₂. The Class VI Program Director (EPA or a delegated state) determines whether a Class VI permit is required based on site-specific risk factors associated with USDW endangerment. To date, no such transition has been required.

The 45Q Tax Credit for Carbon Sequestration⁸¹

Federal tax credits for carbon sequestration were first authorized in 2008 with the enactment of the Energy Improvement and Extension Act (Division B of P.L. 110-343). This act added Section 45Q to the Internal Revenue Code (I.R.C.), which established tax credits for CO₂ disposed of in “secure geologic storage” or through EOR with secure geologic storage.⁸² The Bipartisan Budget Act of 2018 (BBA; P.L. 115-123) amended Section 45Q to increase the tax credit for capture and sequestration of “carbon oxide,” for its use as a tertiary injectant in EOR operations, or for other qualified uses. In 2022, the measure known as the Inflation Reduction Act of 2022 (IRA; P.L. 117-169) made numerous changes to Section 45Q.

Provisions in Section 45Q establish the amount of the tax credit per ton of carbon oxide captured and disposed of, annual CO₂ capture minimums, deadlines for beginning facility construction, and credit claim periods, and direct the U.S. Department of Treasury (Treasury) to issue 45Q regulations, among other provisions. Credit rates, capture minimums, and other provisions differ depending on the type of facility and when the facility or capture equipment was placed in service.

The IRA established the tax rate for facilities or equipment placed in service after December 31, 2022. If projects pay prevailing wages and meet registered apprenticeship requirements, the tax credit amount is \$85 per ton of CO₂ disposed of in secure geologic storage and \$60 per ton of CO₂ used for EOR and disposed of in secure geologic storage, or utilized in a qualified matter.⁸³ For DAC facilities or equipment placed in service after December 31, 2022, that pay prevailing wages and meet registered apprenticeship requirements, the credit is \$180 per ton for CO₂ disposed of in secure geologic storage and \$130 per ton for CO₂ that is used for EOR and disposed of in secure geologic storage, or utilized in a qualified manner.⁸⁴ Credit amounts are adjusted for inflation after 2026. To qualify for tax credits, a point source facility or DAC facility must begin construction by December 31, 2032.⁸⁵ The credit can be claimed over a 12-year period after operations begin.

The IRA increased the credit from the rates that had been established in the BBA. Before the IRA, and for facilities placed in service before 2023, the Section 45Q tax credit amount increases linearly from \$22.66 to \$50 per ton over the period from calendar year 2017 until calendar year 2026 for CO₂ captured and disposed of in secure geologic storage, and from \$12.83 to \$35 per ton over the same period for CO₂ captured and used as a tertiary injectant for EOR or for another qualified use, with tax credit amounts adjusted for inflation after 2026.

A facility must capture a minimum amount of CO₂ to qualify for tax credits under Section 45Q.⁸⁶ For facilities that begin construction after August 16, 2022, DAC facilities must capture at least 1,000 tons of CO₂ per year;

⁸⁰ 40 C.F.R. §144.19.

⁸¹ For additional background, see CRS InFocus IF11455, *The Tax Credit for Carbon Sequestration (Section 45Q)*, by Angela C. Jones and Molly F. Sherlock.

⁸² 26 U.S.C. §45Q. P.L. 115-123 expanded the tax credit to all carbon oxides, which includes CO₂ and carbon monoxide.

⁸³ P.L. 117-169, §13104(b). For facilities that do not meet prevailing wage and apprenticeship requirements, the base credit amount is \$17 per ton for secure geologic storage and \$12 per ton for EOR or other qualified use.

⁸⁴ P.L. 117-169, §13104(c). Prior to the IRA amendments, eligible taxpayers disposing of CO₂ captured through DAC would have received the credit amount for the type of disposal used, either geologic sequestration or EOR/utilization. For facilities or equipment placed in service after December 31, 2022, the base credit amount established in the IRA is \$36 per ton for CO₂ captured using DAC with geological sequestration and \$26 per ton for CO₂ captured using DAC with EOR or qualified utilization.

⁸⁵ P.L. 117-169, §13104(a).

⁸⁶ Taxpayers must physically or contractually dispose of captured carbon oxide in secure geological storage. See IRS Prop. Reg. §1.45Q-1, Prop. Reg. §1.45Q-2, Prop. Reg. §1.45Q-3, Prop. Reg. §1.45Q-4, and Prop. Reg. §1.45Q-5; and

electricity generating facilities must capture at least 18,750 tons of CO₂ per year and have a capture design capacity at least 75% of the unit's baseline carbon oxide production; and other facilities must capture at least 12,500 tons of CO₂ per year.⁸⁷ The amounts established in the IRA are less than what had previously been required. For facilities that began construction by August 16, 2022, and are covered under the BBA, an electricity generating facility that emits more than 500,000 tons of CO₂ per year must capture a minimum 500,000 tons of CO₂ annually to qualify for the tax credit. A facility that captures CO₂ for the purposes of utilization—fixing CO₂ through photosynthesis or chemosynthesis, converting it to a material or compound, or using it for any commercial purpose other than tertiary injection or natural gas recovery (as determined by the Secretary of the Treasury)—and emits less than 500,000 tons of CO₂ must capture at least 25,000 tons per year. A direct air capture facility or a facility that does not meet the other criteria just described must capture at least 100,000 tons per year.

Tax-exempt entities, including state and local governments and electric cooperatives, can elect to receive the Section 45Q tax credits as “direct pay.” This allows these entities to receive the credit amount as a payment, instead of a reduction in tax liability. The IRA allows direct pay for CO₂ captured at facilities placed in service after December 31, 2022. Taxpayers also may be able to elect to receive the Section 45Q tax credit as direct pay, for up to five years, but not after 2032. Taxpayers can also elect to make a one-time transfer of the credit. For equipment placed in service after February 9, 2018, the credit is attributable to the person who owns the carbon capture equipment and physically or contractually ensures the disposal or use of the qualified CO₂. The credits can be transferred to the person who disposes of or uses the qualified CO₂.

Some stakeholders have suggested that the tax credit increases in Section 45Q could be a “game changer” for CCS developments in the United States, by providing incentives sufficient to drive investments in CO₂ capture and storage.⁸⁸ They note that EOR has been the main driver for CCS development, and the new tax credit incentives might result in an increased shift toward CO₂ capture for permanent storage, apart from EOR.

Opponents to 45Q include some environmental groups that broadly oppose measures that extend the life of coal-fired power plants or provide incentives to private companies to increase oil production.⁸⁹ Another factor to consider is the cost. Over the FY2022-FY2031 budget window, Treasury estimates that the tax credit will reduce federal income tax revenue by a total of \$20.1 billion.⁹⁰ Other groups note that measures in addition to the 45Q tax credits will be needed to lower CCS costs and promote broader deployment.

The Internal Revenue Service (IRS) continues to issue guidance and promulgate regulations on implementation of the Section 45Q tax credit. In January 2021, the IRS issued final regulations on demonstration of “secure geologic storage,” utilization of qualified carbon oxide, eligibility, and credit recapture, among other provisions (86 *Federal Register*, January 15, 2021, 4728-4773). The IRS may issue further Section 45Q guidance related to changes enacted in the IRA in the future.

Department of the Treasury, “Credit for Carbon Oxide Sequestration,” 85 *Federal Register* 34050-34075, June 2, 2020.

⁸⁷ P.L. 117-169, §13104(a). For equipment placed in service after the enactment of the BBA on February 9, 2018, and before January 1, 2023, the annual capture requirements are (1) in the case of a facility that emits no more than 500,000 metric tons of carbon oxide, capture at least 25,000 metric tons of carbon oxide that is either fixated through the growing of algae or bacteria, chemically converted into a material or chemical compound in which the carbon oxide is stored, or used for another commercial purpose (other than a tertiary injectant); (2) in the case of an electricity generating facility not described in (1), capture at least 500,000 metric tons of carbon oxide per year; or (3) in the case of a direct air capture facility not described in (1) or (2), capture at least 100,000 metric tons of carbon oxide. For equipment placed in service before February 9, 2018, the capture requirement is 500,000 tons per year.

⁸⁸ Emma Foehringer Merchant, “Can Updated Tax Credits Bring Carbon Capture Into the Mainstream?,” *Greentech Media*, February 22, 2018; James Temple, “The Carbon Capture Era May Finally Be Starting,” *MIT Technology Review*, February 20, 2018.

⁸⁹ Natural Resources Defense Council, “Capturing Carbon Pollution While Moving Beyond Fossil Fuels,” accessed on November 27, 2019, at <https://www.nrdc.org/experts/david-doniger/capturing-carbon-pollution-while-moving-beyond-fossil-fuels>; Richard Conniff, “Why Green Groups are Split on Subsidizing Carbon Capture Technology,” *YaleEnvironment360*, April 9, 2018.

⁹⁰ U.S. Department of the Treasury, “FY2023 Tax Expenditures,” accessed February 17, 2022, at <https://home.treasury.gov/policy-issues/tax-policy/tax-expenditures>.

Discussion

In recent Congresses, proposed and enacted CCS-related legislation has addressed federal CCS research and development (R&D) activities and funding, CO₂ pipelines, and the carbon sequestration tax credit. Bills, or provisions thereof, addressing CCS were enacted as part of the Consolidated Appropriations Act, 2021 (P.L. 116-260). Potential implementation and oversight issues related to these provisions might be of interest in the 117th Congress and beyond.

In the 116th Congress, as part of the Consolidated Appropriations Act, 2021 (P.L. 116-260), Congress reauthorized the DOE CCS research program. Among other provisions, the law expanded the scope of DOE's research to noncoal applications (e.g., natural gas-fired power plants, other industrial facilities).⁹¹ The law also authorized a DOE carbon utilization research program and specific activities related to direct air capture (e.g., a DAC technology prize). IJA built upon this expanded scope, providing supplemental appropriations for several programs authorized by P.L. 116-260, and established new CCS and DAC programs. As is also true for other DOE applied research programs, some criticize such activities as an inappropriate role for government, arguing the private sector is better suited to develop technologies that can compete in the marketplace.⁹²

Council on Environmental Quality 2021 CCS Report to Congress and 2022 CCS Guidance

In response to the USE IT Act, in 2021, the White House Council on Environmental Quality (CEQ) provided Congress with a report on carbon capture, utilization, and sequestration project permitting and review.⁹³ One of several reports required by Congress in the Consolidated Appropriations Act, 2021 (P.L. 116-260), this report provides information on federal permitting and regulations for CCS projects and examines technical, financial, and policy-related issues for project deployment. In its key findings, CEQ states that “CCUS has a critical role to play in decarbonizing the global economy” and that “President Biden is committed to accelerating the responsible development and deployment of carbon capture, utilization, and permanent sequestration as needed to decarbonize the U.S. economy by mid-century.”⁹⁴ CEQ also finds that to be beneficial, CCS projects must be “well-designed and well governed.”⁹⁵ Regarding governance, CEQ also finds that the existing federal regulatory framework is “rigorous and capable of managing permitting and review actions while protecting the environment, public health, and safety as CCUS projects move forward.”⁹⁶

In February 2022, CEQ released an interim guidance, *Carbon Capture, Utilization, and Sequestration Guidance*, also as directed by Congress in the USE IT Act.⁹⁷ The interim guidance

⁹¹ For additional information, see CRS In Focus IF11861, *DOE's Carbon Capture and Storage (CCS) and Carbon Removal Programs*, by Ashley J. Lawson.

⁹² See, for example, Heritage Foundation, “Eliminate the DOE Office of Fossil Energy,” in *Budget Blueprint for FY2022*.

⁹³ CEQ, *Council on Environmental Quality Report to Congress on Carbon Capture, Utilization, and Sequestration*, <https://www.whitehouse.gov/wp-content/uploads/2021/06/CEQ-CCUS-Permitting-Report.pdf>. The report to Congress is required by P.L. 116-260, Division S, §102.

⁹⁴ CEQ CCS Report, p. 8.

⁹⁵ CEQ CCS Report, p. 8.

⁹⁶ CEQ CCS Report, p. 8.

⁹⁷ Council on Environmental Quality, “Carbon Capture, Utilization, and Sequestration Guidance,” 87 *Federal Register*

includes recommendations for federal agencies that would support “the efficient, orderly, and responsible development and permitting of CCUS projects at an increased scale in line with the Administration’s climate, economic, and public health goals.”⁹⁸ In the document, CEQ provides guidance to federal agencies on the processes for permitting and review of CCS projects and CO₂ pipelines, public engagement, and assessing environmental impacts of CCS projects.

Other CCS Policy Issues

With respect to other issues for congressional consideration, costs have been, and remain, a key challenge to CCS development in the United States. In recent years, Congress has attempted to address this challenge in two main ways—federal R&D and federal tax credits. P.L. 116-260 and P.L. 117-169 also extended the start of construction deadline for facilities claiming the 45Q tax credit. In January 2021, the IRS promulgated regulations establishing requirements for carbon storage under Section 45Q. Congress remains interested in the efficacy of the tax credit in promoting CCS development and could consider additional adjustments.

The issue of expanded CCS deployment is closely tied to the issue of reducing greenhouse gas emissions to mitigate human-induced climate change. In 2021, the Biden Administration announced climate change mitigation goals and strategies, and new climate-focused groups and initiatives that may also be of interest when considering CCS-related oversight, appropriations, or legislation. In two executive orders signed in January 2021, President Biden outlined new federal climate policies; created new White House and Department of Justice climate offices; and established new task forces, workgroups, and advisory committees on climate change science and policy.⁹⁹ At this early stage, the implications of these executive branch policies and actions on CCS project development and deployments are unclear.

The use of CCS technology as a greenhouse gas emissions reduction approach is not uniformly supported by advocates for actions to address climate change.¹⁰⁰ Some argue that CCS supports continued reliance on fossil fuels, which runs counter to their view of how to reduce greenhouse gas emissions and meet other environmental goals. They tend to prefer policies that phase out the use of fossil fuels altogether. Others raise concerns about the long-term safety and environmental uncertainties of injecting large volumes of CO₂ underground.

8808-8811, February 16, 2022. The CEQ guidance is required by P.L. 116-260, Division S, §102.

⁹⁸ Council on Environmental Quality, “Carbon Capture, Utilization, and Sequestration Guidance,” 87 *Federal Register* 8808-8811, February 16, 2022, p. 8809.

⁹⁹ Executive Order 13990, *Protecting Public Health and the Environment and Restoring Science to Tackle the Climate Crisis*, January 20, 2021; and Executive Order 14008, *Tackling the Climate Crisis at Home and Abroad*, January 27, 2021.

¹⁰⁰ For example, in its May 2021 interim final recommendations, the White House Environmental Justice Advisory Council (WHEJAC) listed CCS projects as among those projects that would not benefit communities (WHEJAC, *Justice40, Climate and Economic Justice Screening Tool & Executive Order 12898 Revisions: Interim Final Recommendations*, May 13, 2021). See also Carlos Anchondo, “Industry Warns Lawmakers of CCS Threats,” *Energywire*, November 25, 2019; and Richard Conniff, “Why Green Groups Are Split on Subsidizing Carbon Capture Technology,” *YaleEnvironment360*, April 9, 2018.

Author Information

Angela C. Jones
Analyst in Environmental Policy

Ashley J. Lawson
Analyst in Energy Policy

Acknowledgments

CRS Specialist Paul Parfomak provided substantial contributions to the CO₂ Transport Section of this report. CRS Specialist Peter Folger authored the original version of this report. CRS Intern Claire Mills contributed research related to lifecycle greenhouse gas emissions for different enhanced oil recovery processes.

Disclaimer

This document was prepared by the Congressional Research Service (CRS). CRS serves as nonpartisan shared staff to congressional committees and Members of Congress. It operates solely at the behest of and under the direction of Congress. Information in a CRS Report should not be relied upon for purposes other than public understanding of information that has been provided by CRS to Members of Congress in connection with CRS's institutional role. CRS Reports, as a work of the United States Government, are not subject to copyright protection in the United States. Any CRS Report may be reproduced and distributed in its entirety without permission from CRS. However, as a CRS Report may include copyrighted images or material from a third party, you may need to obtain the permission of the copyright holder if you wish to copy or otherwise use copyrighted material.